

OptiREC
Custom Surgical®





User Manual



OptiREC is a product by Custom Surgical GmbH, Munich, Germany, the owner of a trademark and all copywriting rights ©. Any piece of the product, app or supportive materials cannot be replicated or used without the permission of Custom Surgical.

For more details, visit our website:
customsurgical.co

© All right reserved.

<p>Name and address manufacturer information and symbol ISO 7000 - 3082</p>	
<p>Product Name</p>	<p>OptiREC</p>
<p>Medical device symbol ISO 15223 - 1:2021</p>	
<p>Read the instructions symbol ISO 7000 - 1641</p>	
<p>Reference mark</p>	
<p>Serial Number</p>	

Summary

1. A Thank You Note	5
2. Package Content	7
3. How to Install	8
3.1. Ocular grip part	8
3.2. Universal Holder Part	16
4. Get Your OptiREC Ready for Use	20
5. Intended Use	25
6. Cleaning and Maintenance	26
7. Warnings and Safety	27
8. Warranty	28
8.1. Warranty	28
8.2. How to Claim a Warranty	30
9. The MicroREC App	31
9.1. Intended Use	31
9.2. MicroREC App and MicroREC Connect	31
9.3. How to Download the App	33
10. FAQs	34
11. Contacts	35

1. A Thank You Note

Hello, Customer!

We at Custom Surgical really appreciate your trust.

Now you can enjoy the easiest way of capturing, sharing, and broadcasting your procedures or examinations.

Forget about cables, computers, or USB devices. Your time should be spent on what really matters.

Share your images with colleagues, students, and partners in just a few clicks with the MicroREC app. Use the hashtag #OptiREC to share them with us as well! We would love to promote your procedures on our social media accounts.

Website: customsurgical.co

Instagram: @customsurgical

Facebook: @customsurgical1

LinkedIn: @customsurgical

Don't forget to boost the quality of your recordings and organize them in the best way through the MicroREC app.

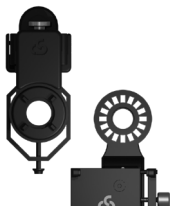

download for free

2. Package Content

The package contains an Ocular Grip, a Universal Holder and a user manual.

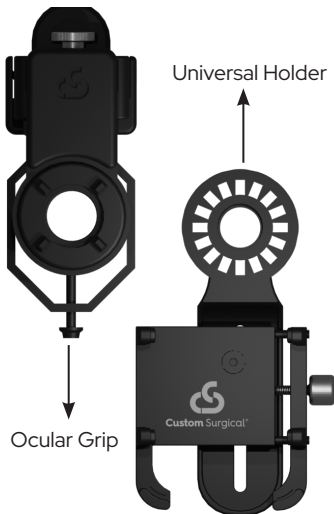

3. How to Install

3.1. Ocular grip part

Step 1. Open the grip.

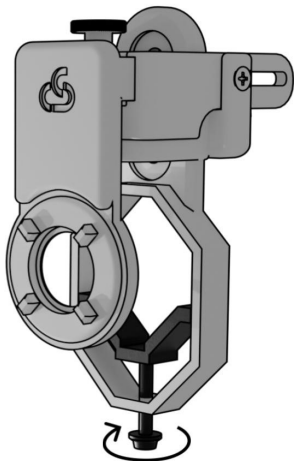

Step 2. Loosen the thumbscrew.

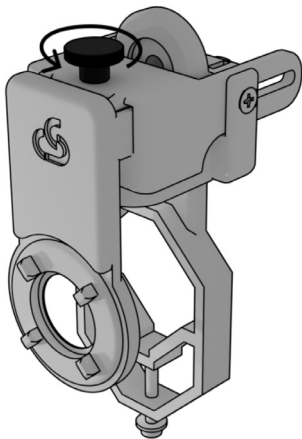

Step 3. Loosen the knob.

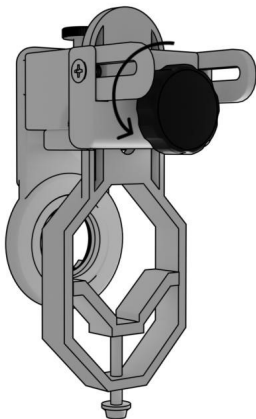

Step 4. Locate the OptiREC system in the ocular as shown in the image.

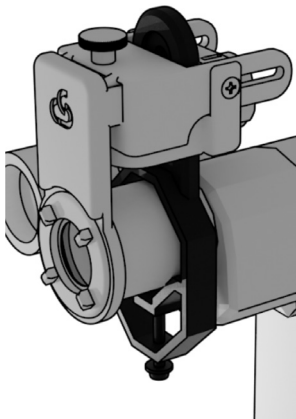

Step 5. Screw until it is tightened and does not move.

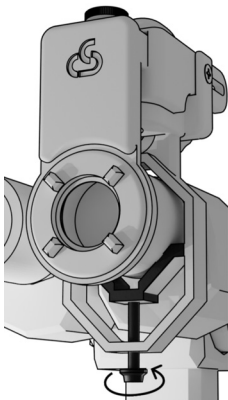

Step 6. Move the system vertically until the circle is concentric (1) to the ocular, then tighten the knob (2).

1.

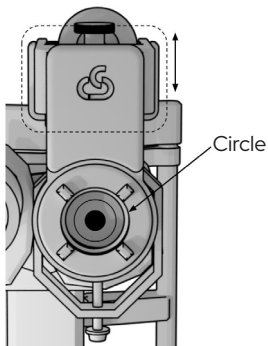

2.

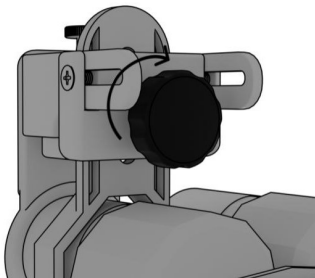

Step 7. Adjust the horizontal rail until it is in contact with the ocular surface.

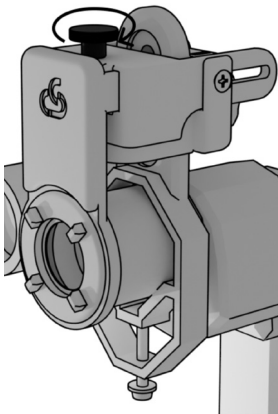

Step 8. Tighten the thumbscrew until it remains fix.

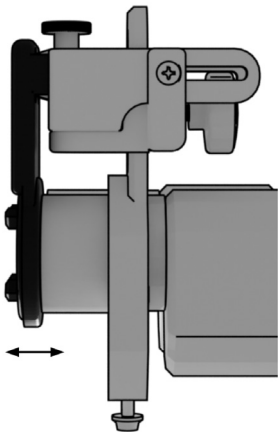

3. 2. Universal Holder Part

Step 1. Intall the smartphone in the Universal Holder and tighten the knob of the Universal Holder to secure the smartphone.

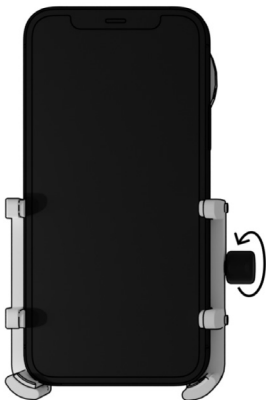

Step 2. Adjust the knob to slide and rotate the arm until the circle is aligned with the main camera* of the smartphone.

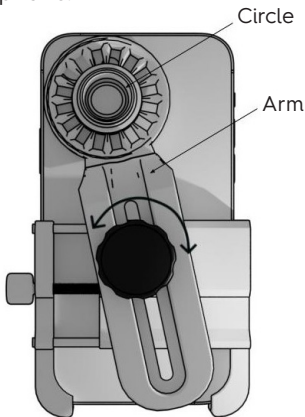

*In order to confirm which is the main camera, cover the different cameras until you see the screen of your phone covered.

Step 3. Check the distance and alignment of the camera with the Universal Holder. If the distance is not appropriate remove the arm's knob and the arm to remove the spacers. Remove as many as you need to achieve the correct distance.

Note: If the camera is too close, when you tighten the arm's knob, the camera may be tilted.

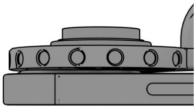
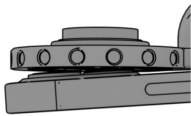
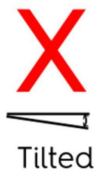
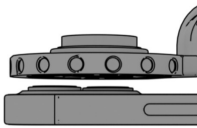
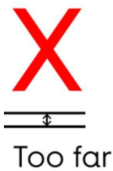

4. Get Your OptiREC Ready for Use

Step 1. Position the Universal Holder in the circular path

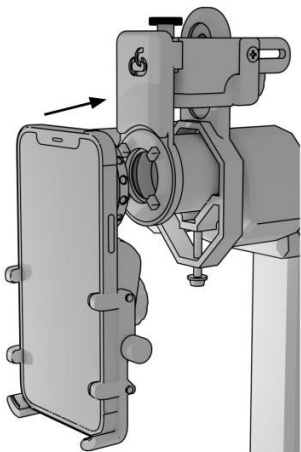

You can do it either in landscape or portrait position.

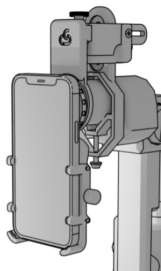

portrait

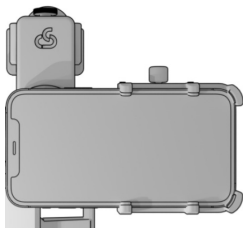

landscape

Step 2. Open the MicroREC app in your smartphone (remember to download it previously) to enhance your recording experience. You are ready to go!

Step 3. Slide and rotate your smartphone with the Universal Holder until the camera is aligned with the Ocular Grip's optical opening. Move it until you can see a perfect shaped circle with no shadows.

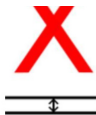

Too far

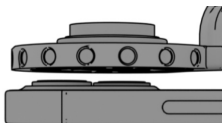

X Incorrect alignment. Shadows in the border of the image.

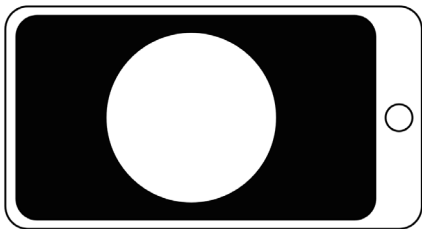

✓ Correct alignment. Sharp border.

Step 4. Leave the ocular free by detaching the Universal Holder from the Ocular Grip and rotating the system.

1.

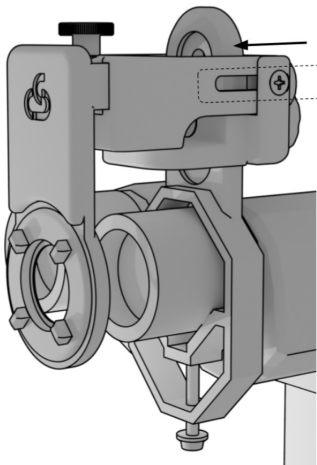

2.

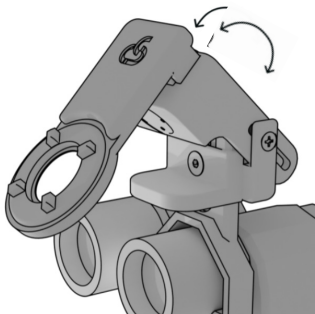

3.

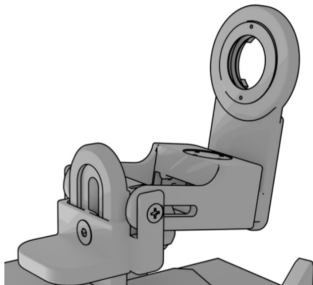

Start over and take as many photos as you need.

5. Intended Use

OptiREC is a device designed for afocal photography with slit lamps, to capture pictures of patient's eyes in a medical setting.

6. Cleaning and Maintenance

The OptiREC is shipped and used as a non-sterile product.

- To do regular cleaning, use damp cloth. Only use pure water in small quantities to clean the product.
- Do not sterilize your OptiREC device.
- If the product gets in contact with abundant liquid, wipe it immediately with a soft cloth. In case the liquid enters an unreachable surface, place the product in a way that the liquid may exit.
- Do not dismantle the device or directly manipulate the screws.lenses.

7. Warnings and Safety

- Verify the physical integrity of the product before using it.
- Check the product contents before using it.
- Use only indoors.
- Store the device in a clean and safe location.
- Do not place heavy objects on top of the product.
- Do not expose the product or any of its components to high temperatures.
- Keep out of the reach of children.
- Do not shake the device violently.
- Do not apply excessive force when mounting it. The device is designed to fit properly.

8. Warranty

8.1. Warranty

We allow you to return your product during the first **14 days after you received it** and to claim a full refund of the product cost after delivery.

We provide a **2-year warranty** for the adapter to ensure that there are no material or production defects. All manufacturing issues reported within 2 years after delivery will be entitled to a replacement or a fix at **no extra cost**.

The warranty does not cover:

- damages or defects caused by misuse
- neglect
- accidental damage
- falls
- loss failure to follow operating instructions

- alteration, modification, or repair of the product including that caused by authorized workshops or persons.
- damage caused by wars, natural disasters, terrorism, or extreme conditions, and Custom Surgical leaves it up to whether to cover such claims for reparation or replacements.

The warranty covers all products purchased on our website, through official distributors, or sold by us or our partners on authorized marketplaces. We cannot apply the warranty to products purchased from unauthorized third parties or resellers.

The warranty is subject to the law of Germany.

8. 2. How to Claim a Warranty

Make sure you have the following things before you claim your warranty:

1. Original packaging
2. The receipt of your purchase

If you purchased the product through the authorized distributor

Please contact your distributor and follow their instructions. You can ask us about the contact information for the distributor via Whatsapp:

+49 178 2064226

If you purchased the product through customsurgical.co

Please contact us at
support@customsurgical.co

10. FAQs

1. Do you have a manual in different languages?

Yes, we have this manual in English, German, Spanish, and Portuguese. To download a manual in these languages, please go to our website:
customsurgical.co/manuals

2. Is my slit lamp compatible with OptiREC?

support@customsurgical.co
+49 178 2064226

3. Can I use any smartphone with the OptiREC?

You can attach any smartphone to your OptiREC. To use the MicroREC app, you have to follow one of these requirements: iOS 13.5 or later for iPhones, Android 7.0, and up for other smartphones.

OptiREC

Custom Surgical®

USER MANUAL

customsurgical.co