

MicroREC

Accessory







User Manual **Beam Splitter**

MicroREC is a product by Custom Surgical GmbH, Munich, Germany, the owner of a trademark and all copywriting rights. Any piece of the product, app or supportive materials cannot be replicated or used without the permission of Custom Surgical.

For more details, visit our website:
customsurgical.co

Custom Surgical GmbH.

© All right reserved.

Name and address manufacturer information and symbol	
Product Name	MicroREC Beam Splitter
Medical device symbol	
CE mark	
Read the instructions symbol	
Reference mark	
Serial Number	

Summary

1. A Thank You Note	5
2. Package Content	7
3. How to Install	10
3. 1. How to Install a MicroREC Beam Splitter on a Microscope	10
3. 2. How to Install a MicroREC Beam Splitter on a Slit Lamp	15
4. Intended Use	20
5. Cleaning and Maintenance	21
6. Warnings and Safety	22
7. Warranty	23
10. Contacts	25

1. A Thank You Note

Hello, Customer!

We at Custom Surgical really appreciate your trust.

Now you can enjoy the easiest way of recording, sharing, broadcasting, and connecting your procedures with your smartphone.

Forget about cables, computers, or USB devices. Your time should be spent on what really matters.

Share your procedures with your colleagues, students, and partners or with us in just a few clicks. Share them with the hashtag **#MicroREC!**

We would love to share your procedures on our social accounts.

Website: customsurgical.co

Instagram: @customsurgical

Facebook: @customsurgical1

LinkedIn: @customsurgical

Don't forget to boost the quality of your recordings and organize them in the best way through the MicroREC app.



download for free

2. Package Content

Depending on the selected model, the package may include whichever of the following products, you can identify them by the model reference in your box's label or the product's serial number.

BSZ: Beam Splitter Type Z

BSL: Beam Splitter Type L

BSH: Beam Splitter Type H



Type Z



Type L



Type H

3. How to Install

3.1. How to Install a MicroREC Beam Splitter on a Microscope

MicroREC Beam Splitter Type L (BSL) and Beam Splitter Type Z (BSZ) can be installed on Microscopes depending on the model.

Step 1. Loosen the thumbscrew in the optics body to remove the binoculars.

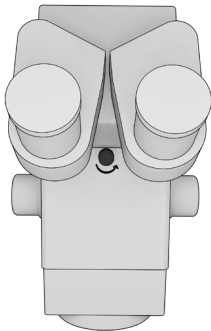

Step 2. Remove the binoculars.

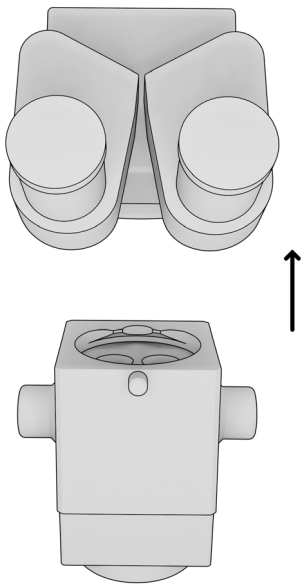

Step 3. Install the Beam Splitter in between the binoculars and the optics body.

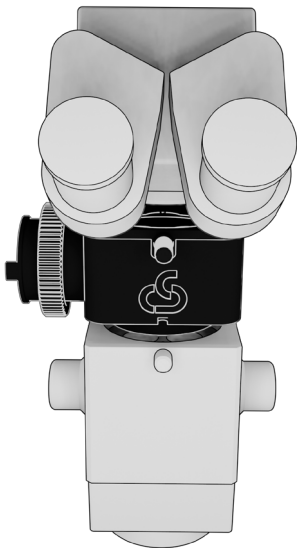

Step 4. Tighten the thumbscrews of the optics body and the Beam Splitter to safely secure the binoculars and the beam splitter.

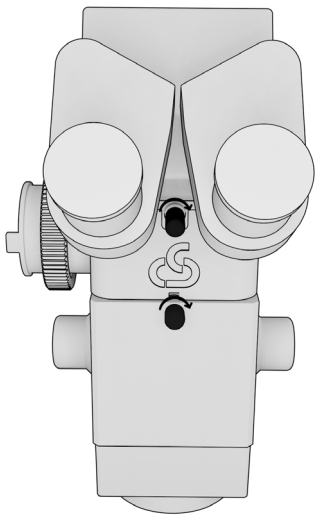

Step 5. Install the MicroREC in the Beam Splitter lateral port.

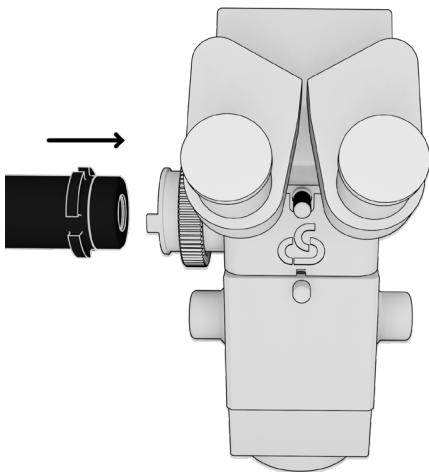

3. 2. How to Install a MicroREC Beam Splitter on a Slit Lamp

The Beam Splitter Type Z (BSZ) and the Beam Splitter Type H (BSH) can be installed on slit lamps depending on the model.

Step 1. Loosen the binoculars either by loosening a thumbscrew or turning a lock wheel.

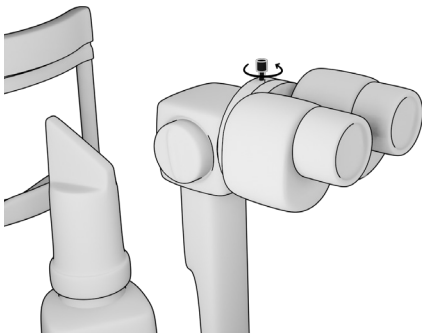

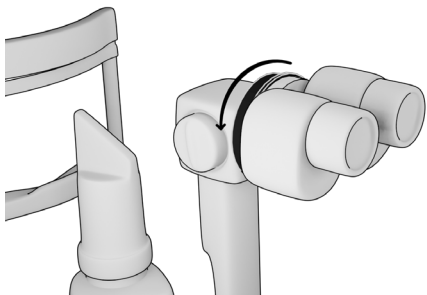

Step 2. Remove the binoculars.

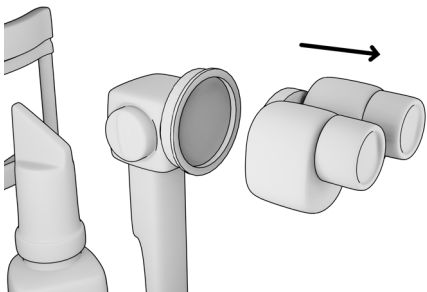

Step 3. Install the Beam Splitter in between the binoculars and the optics body.

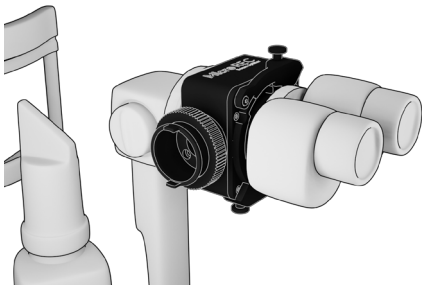

Step 4. For Haag-Streit slit lamps open the latches in the beam splitter.

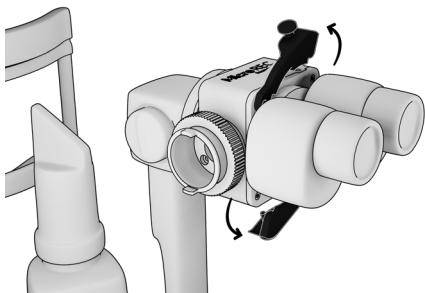

Step 5. Secure the Beam Splitter and the binoculars, tightening all the thumbscrews.

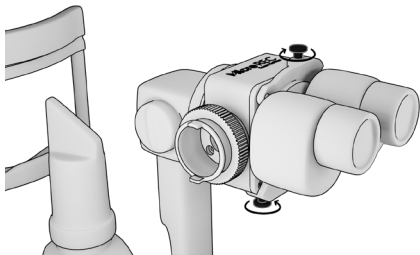

Step 6. Install the MicroREC system.

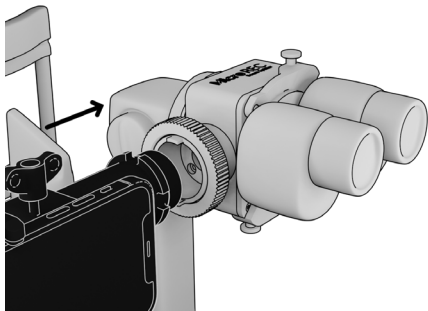

4. Intended Use

The MicroREC Beam Splitter Accessory is an optical system intended to be used in fitting microscopes and slit lamps in order to help capture images with a smartphone.

This device is **not** intended to be a diagnostic device.

5. Cleaning and Maintenance

- Remember to clean your MicroREC Beam Splitter Accessory regularly.
- Use a special optics cloth to clean it.
- Clean the optics using only small quantities of pure water. Do not use corrosive liquids or oils for cleaning. Never touch the optics with your fingers.
- Do not sterilize your MicroREC Beam Splitter Accessory.
- If the product gets in contact with abundant liquid, wipe it immediately with a soft cloth. In case the liquid enters an unreachable surface, place the product in a way that the liquid may exit.
- Do not dismantle the device or directly manipulate the screws or the lenses.
- If you detect spots, dust, or residue, use a soft cloth for lenses to clean.

6. Warnings and Safety

- Verify the physical integrity of the product before using it.
- Check the product contents before using it.
- Use only indoors.
- Store the device at a clean and safe location.
- Do not place heavy objects on top of the product.
- Do not expose the product or any of its components to high temperatures.
- Keep out of the reach of children.
- Do not shake the device violently.
- Do not apply excessive force when mounting it. The device is designed to fit properly.

7. Warranty

We allow you to return your product during the first **14 days after you received it** and to claim a full refund of the product cost after delivery.

We provide a **2-year warranty** for the product to ensure that there are no material or production defects. All manufacturing issues reported within 2 years after delivery will be entitled to a replacement or a fix at **no extra cost**.

The warranty does not cover:

- Damages or defects caused by misuse
- Neglect
- Accidental damage
- Falls
- Failure to follow the instruction manual
- Devices that have been dismantled
- Devices that have been sterilized

- Alteration, modification, or repair of the product including that caused by authorized workshops or persons.

The warranty covers all products purchased on our website, through official distributors, or sold by us or our partners on authorized marketplaces. We cannot apply the warranty to products purchased from unauthorized third parties or resellers.

The warranty is subject to the law of Germany.

10. Contacts

We're always here for you.

Find more information at
customsurgical.co

To get any additional help or share your feedback, please reach out to support@customsurgical.co



Let's connect on social media!
Tag [@customsurgical](#), [#customsurgical](#)
and [#MicroREC](#)

MicroREC

Accessory

USER MANUAL

MicroREC Beam Splitter Accessory
is a Product by Custom Surgical.

customsurgical.co